



Single Pump Protection and Control Module Professional Series

BIA-nXt-SPC 1-22 Pro

PN 811361

BIA-nXt-SPC 1-22 Pro S/S

PN 811366

Installation and Operation Manual



A. Shortcuts

Switching between AUTO and MANUAL:

PRESS and release the **MODE** button

Note: All pump protections are valid in MANUAL state

Switching to Manual if the controller is in LOCK MODE:

PRESS and HOLD the **MODE** button for 5 seconds

Lock parameter # 011 in the Expert Menu Pg 13

Error log:

- Switch to MANUAL mode
- Ensure no pumps are running.
- PRESS and HOLD the **STOP** button, then SHORT PRESS the **MODE** button
- Press **MODE** to scroll
- Press **STOP** to exit

Accumulated Run time:

Controller in manual state. Press and hold **STORE/SET** then press **START**

START

STOP

MODE

STORE
SET

Single Phase SPC-1

Set Parameter 007: OFF
Set Parameter 008: OFF
Set Parameter 010: Minimum 1 sec
Set Parameter 022: OFF

Full factory reset

- Turn off power to the control panel,
- Press and hold the **STOP** button and reapply power
- When the display shows 099, release the **STOP** button.

B. Shortcuts cont

Calibrating the controller to the pump

In manual mode, short press **START**. Allow the pump to run and the current draw to stabilise.

Once you are satisfied the pump is in its 'normal' operating range short press **STORE/SET** The controller should chirp.

Press **MODE** to exit

The controller calibration value can be checked and adjusted from the User Menu
Parameter #018 in the User Menu Pg 13

To clear the calibration

With the pump stopped and the controller in manual mode, PRESS and HOLD the **STOP** button for 5 seconds

User Programming menu

Parameter 018 onwards
In manual mode, press and hold **STORE/SET** for 5 sec
Page 13

Expert Programming menu

Parameter 003 onwards
In manual mode, press the **STORE/SET** then the **MODE** button and hold both for 5 sec.
Page 12

START

STOP

MODE

STORE
SET

Programming:

Short press **STORE/SET** to store a value and advance to the next parameter

START increases a value

STOP decreases a value

Press **MODE** for to save changes and exit

1. Introduction

Bianco nXt-SPC Pro Single Pump Logic Control and Protection panel is intended for use in industries which require a pump controller in a secure, professional quality, metal enclosure.

nXt-SPC-1 panels are designed to control and protect an individual single phase pump. The user can configure the control inputs to suit their application and enjoy the benefits of superior control logic and pump protection. With a choice of powder coated or stainless steel, the robust, lockable enclosure is weather-proof and tamper proof.

There are 3 primary control logic modes:







- ‘Drainage’ where control is concentrated at the source
- ‘Boosting’ which references pressure switching on the delivery side for control
- ‘Transfer’ which is a mix of source and destination control

nXt-SPC is equipped with a RS485 modbus interface to connect to a BMS. The LCD screen displays the pump running state and provides the user a wealth of useful information.

The controller is easy to set up with an initial push button calibration and individual parameters can be fine-tuned.

A nXt-SPC controller is particularly useful where there is the need to control and protect pump installations managing the automatic operation through a variety of switching methods without the need to create a bespoke control solution.





2. Warnings and Cautions

| | |
|---|---|
|  | Read the manual carefully before starting |
|  | Prior to starting installation or maintenance the controller must be disconnected from the power supply. |
|  | Any changes or modification to the wiring must be carried out by competent, skilled and suitably qualified personnel only. |
|  | A qualified electrician should correctly size and install circuit breakers to protect the power supply. The fitment of additional surge protection is recommended as good practice. |
|  | Never open the cover while controller is connected to electrical supply. Disconnect and allow the internal electronics to discharge before opening the cover |
|  | This appliance is not intended for use by persons (including children) with reduced physical, sensory or mental capabilities, or lack of experience and knowledge, unless they have been given supervision or instruction concerning use of the appliance by a person responsible for their safety. Children should be supervised to ensure that they do not play with the appliance. |
|  | Ensure the controller is a suitable size for the pump motor (see Section 5, Page 6: Technical Data). Size according to full load current amperage. |

3. Contents

- A. Shortcuts 2 - 3**
- 1. Introduction 4**
- 2. Warnings and Cautions 4**
- 3. Contents 5**
- 4. ISO 7010 Symbols used in this manual..... 5**
- 5. Technical Specifications 6**
- 6. Display 8 and 9**
- 8. Electrical Connections..... 9**
- 9. Modbus 11**
- 10. Parameter Calibration..... 11**
- 11. Program Parameters 12**
- 12. Quick guide: Drainage Mode, floats connected to controller 15**
- 13. Quick guide: Drainage Mode, probes connected to controllers..... 16**
- 14. Quick guide: Drainage Mode, float connected to pump..... 16**
- 15. Quick guide: Pressure Boosting – switched input..... 17**
- 16. Quick guide: Transfer – source/destination control..... 18**
- 17. Quick guide: Drainage Mode - 4–20mA level transmitter 19**
- 18. Quick guide: Pressure Boosting - 4-20mA pressure sensor 20**
- 19. Quick guide: Transfer – source/destination control 4-20mA level sensor 21**
- 20. Backup power supply..... 22**
- 21. Fault Messages 24**
- 21. Warranties – Terms and Conditions 25**

4. ISO 7010 Symbols used in this manual

| | |
|---|--|
|  | Warning - Electrical safety |
|  | Warning – Potential consequences of use outside of intended application(s). Includes environmental condition warnings. |
|  | Mandatory warning |
|  | Warning to disconnect power |
|  | Read carefully |

5. Technical Specifications

| | |
|---------------------------------------|--|
| Controller Modes | Automatic or Manual pump operation. Liquid level control via float switch, electrode probes OR 4-20mA level transducer. Pressure control via pressure switch or 4-20mA transducer |
| Protection functions: | Dry run (Underload), Overload, Pump Stalled, Transient surge, Under voltage, Over voltage, Repeated start, Short circuit, Over temperature <i>Over temperature requires an optional relay</i> |
| Input Voltage | 230V +10% -6% |
| Rated output power | SPC 1-22 nominal 0.37 to 2.2 kW P2 power (max 18A input) |
| Minimum working current | SPC 1-22 = 1 amp |
| Working temp | -25 to +55 deg C 20% to 90% relative humidity, non-condensing |
| Enclosure dimensions | 350 mm wide, 220mm deep, 450mm tall IP54 Total height including alarm = 500mm |
| Trip response times (set) | Open phase – Less than 2 sec Short circuit – less than 0.1 sec |
| Trip Voltage (User adjustable) | Over voltage – Default = 276V Under voltage – Default = 192V |
| Trip response times (User adjustable) | Dry run (Under-load) 5 sec Under Voltage Less than 5 sec Over voltage Less than 5 sec |
| Recovery times (User adjustable) | Dry run (Under-load) 45 min default Overload 4 min default Under Voltage 4 min default Over voltage 4 min default |
| RS485 Technical interface | RS485 Bus Interface: asynchronous semi duplex 1200,2400,4800,9600 bps (default 9600bps) MODBUS protocol (RTU) |
| Alarms | Visual and audible alarm |



To avoid 'nuisance' alarming, many of the default protection parameters have values with a wide tolerance. The installer is encouraged to optimise the settings to achieve optimum results

6. Display

The nXt-SPC display provides a real time indication of the operational mode and the current state of the controller, including real-time voltage/current and any error messages.

Only the icons relevant to the current operational state will display.

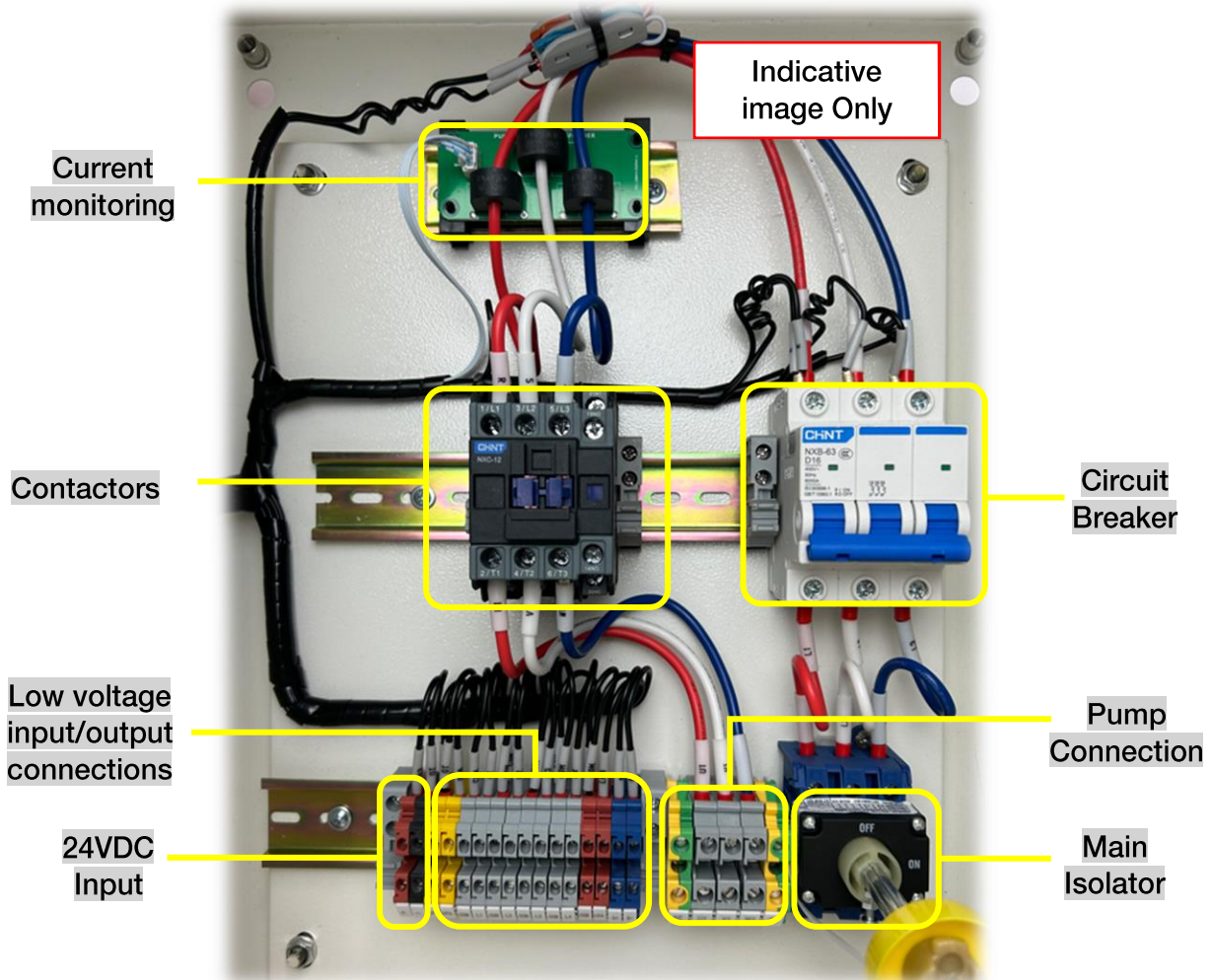
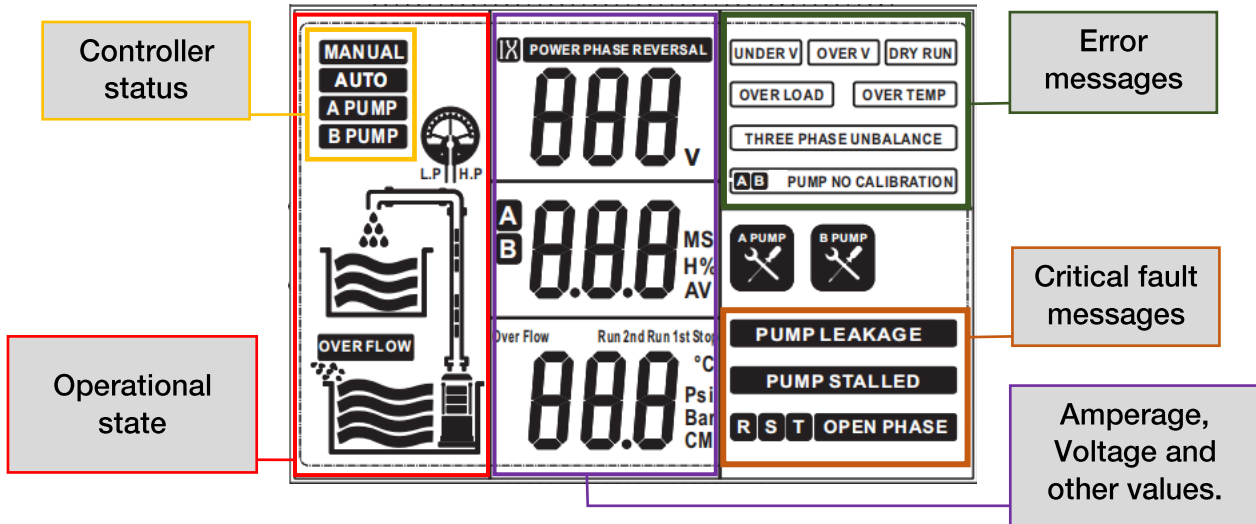

7. Display con't



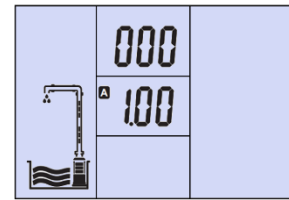

When first powered on the nXt-SPC Pro will briefly display the hardware and the software version.



The nXt-SPC Pro controller operates according to the pre-programmed logic in the control module. Different modes are selected by altering Parameter 003

Examples of common applications are detailed later in this manual but with an understanding of how the controller responds to various inputs the controller can be used for applications other than what is suggested.

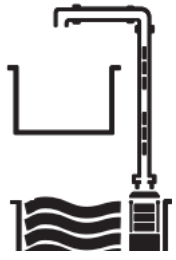
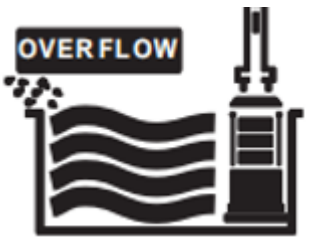
The appearance of the front display changes according to each mode and provides a visual indication to the state of the input signals.

| | | | |
|---|----------------------|--|-------------------------------------|
|  | Lack of source water |  | High pressure or Low pressure state |
|  | Source water full |  | Destination low |
|  | Overflow |  | Destination full |

Avoid installing the nXt-SPC where it could experience the following conditions:

- i. Where there is significant vibration and/or mechanical shock.
- ii. Where it could be exposed to corrosive liquids or gasses, or to flammable materials, solvents etc.
- iii. Extreme heat and cold. Operating range -25°C - 55°C.
- iv. Protect the controller from rain, moisture, humidity or dust



8. Electrical Connections

Always use an electrical outlet that is protected by Residual Current Device (RCD) Safety Switch with a trip current of 30mA or less. A Safety switch is required by Australian/New Zealand Standard AU/NZS 60335.1-2011.



All high voltage wiring must be connected by a suitably qualified technician.

PLC Connections

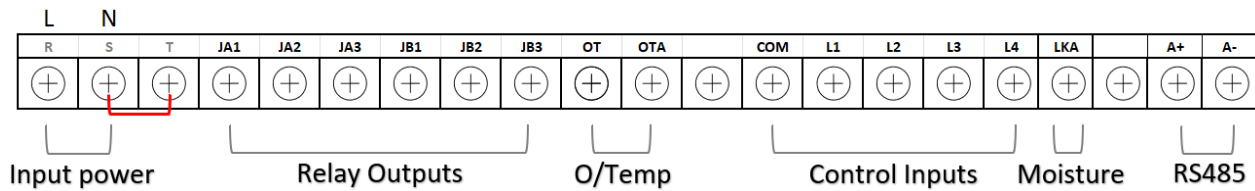

Ensure the green connector blocks in the bottom of the PLC module are plugged in fully. The PLC can be replaced without disturbing any of the wiring

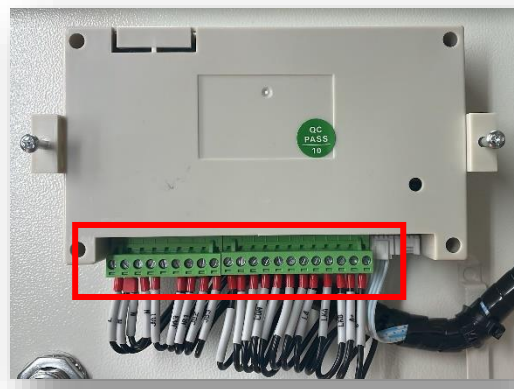

Pre-wired cabinet terminals

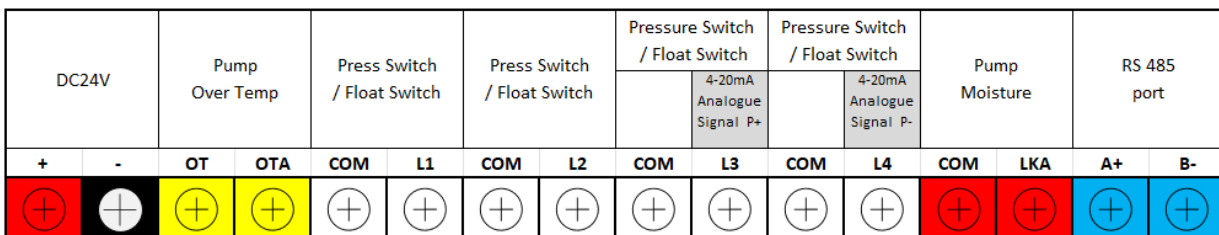
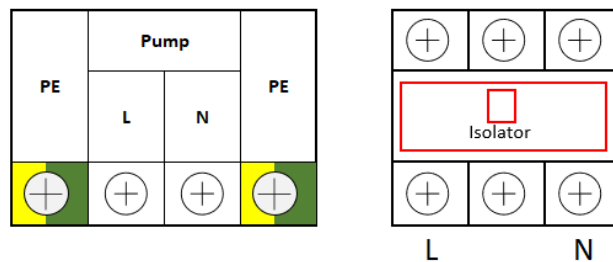

8. Electrical Connections cont

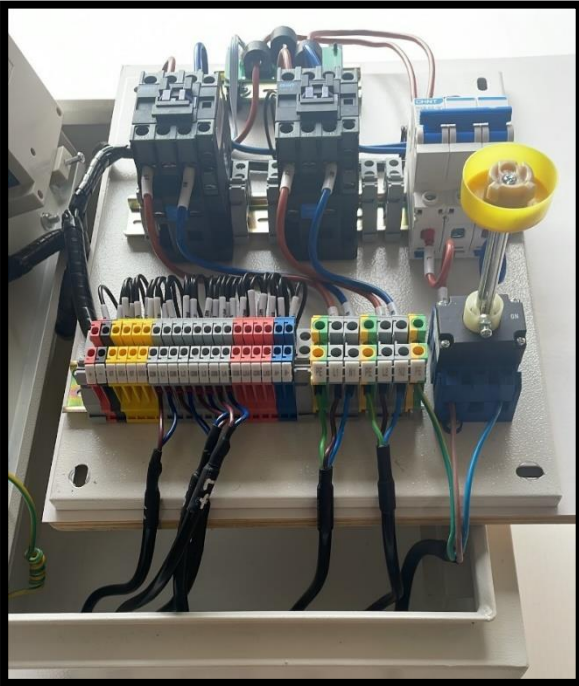

The internal sub board may be lifted free of the outer casing by removing the four M6 (10mm A/F) nuts and snipping the two plastic cable ties

An additional 220mm of cable length is necessary

Total length (past cable gland)
approx. 350mm

Ensure the power supply wiring is rated for the current draw of BOTH pumps



It is the responsibility of the installing electrical technician to ensure that the cable cross section (mm²) meets the requirements of AS/NZS 3008; taking into consideration the cable type, the cable length, the current draw and other relevant factors.

If in doubt, online resources exist i.e. Cable Size Calculator AS/NZS 3008 or seek advice from an electrical engineer or other suitably qualified person(s)

| Pump over temperature protection sensor wiring terminal | |
|--|--|
| OT and OTA | Pump over-temp protection sensor. Standard thermals will open to peak signal and stop pump on overheat PT100 connection. The circuit looks for the variable signal from a PT100 sub board |
| Pump moisture protection sensor wiring terminal | |
| COM and LKA | Pump leakage protection (moisture) sensor |
| 4-20mA transmitter wiring | |
| L3 (P+) and L4 (P-) | 4-20mA level/pressure transmitter |
| RS485 communication terminal | |
| A+ and B- | RS 485 |

9. Modbus

| Main technical data | |
|-----------------------------|---|
| Physical interface | RS485 Bus Interface: asynchronous semi duplex |
| Data format | 1 start bit, 8 data bit, 1 stop bit, no verify 1 start bit, 8 data bit, 2 stop bit, no verify Default: 1 start bit, 8 data bit, 1 stop bit, no verify |
| Baud rate | 1200,2400,4800,9600 bps (default 9600bps) |
| Communication address | Setting range of controller address: 1-126. 127: broadcast address, host computer broadcasting, slave machine response forbidden |
| Protocol type | MODBUS protocol (RTU) |
| Rated input voltage for SC | AC 240V/50Hz, single phase |
| Main installation data | |
| Wire communication distance | 1200 m max by shield twisted pair cable (STP)for RS485 & CAN 5000 m max by STP and RS485 extender |
| STP | STP-120U one pair 20AWG for RS485 & CAN |

10. Parameter Calibration



The pump must be able to pump water to enable correct calibration. Calibrated without water, overload and pump stalled errors may occur later. Calibration can be performed automatically as explained on Page 3 OR by accessing the User parameter menu #018 and manually inputting the desired value

When a new pump is installed, or an existing pump reinstalled after maintenance, erase the former calibration and a perform a fresh calibration.



To access parameter settings the controller should be in **Manual Mode** and the pump should NOT be running.

User Menu: Press the **STORE/SET** button for **5 seconds**

Expert Menu: Press and hold the **STORE/SET** button then quickly press and hold the then **MODE** button for **5 seconds**

The **STORE/SET** button advances to the next parameter and displays the current value.

To increase a value, press **START**

To decrease a value press **STOP**

Short press of the **MODE** button to save all changes and exit

11. Program Parameters

Controller unlocked

Press  to switch between AUTO and MANUAL mode

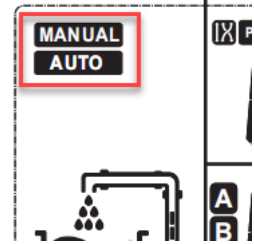

Controller locked (Parameter 014 active)

Press and hold  for 5 sec to switch to MANUAL mode

The controller operating mode will be displayed in the top left corner of the display

| ITEM | DEFAULT | OPERATION |
|------|------------|---|
| 003 | 00 | <p><u>Controller Operation Logic</u></p> <p>00 = 'Drainage' Mode where the control inputs (generally level floats or probes) are located at the source. (default)</p> <p>01 = 'Drainage' Mode where the level control input is managed by a flexible float on the pump.</p> <p>02 'Pressure Boosting' Mode. Main control via (N/C) pressure switch. Supports run / no run level protection at the source via floats or probes.</p> <p>03 = 'Transfer' Mode. Main control via control inputs (floats or probes) at destination or by a pressure switch on the delivery line. Supports run / no run level protection at the source.</p> <p>04 = 'Drainage' Mode with overflow alarm through a 4-20mA level transmitter. Program levels (cm)</p> <p>05 = 'Pressure Boosting' Mode controlled via a 4-20mA pressure transmitter. Supports run / no run level protection at the source via floats or probes. Program pressures (bar)</p> <p>06 = 'Transfer Mode' with 4-20mA level transmitter at the destination. Supports run / no run level protection at the sources via floats or probes. Program levels (cm)</p> |
| 004 | 05 sec | <p>Pump Stall Delay Time (in-rush current ignore time) Range: 0 – 60 sec</p> |
| 005 | Off | <p>Boosting mode only - Repeated start protection Values greater than 0 represent maximum starts in a 1minute period before repeat start protection activates Range: 0 – 50</p> |
| 006 | Off | <p>Over temp Protection Options: On / Off</p> |
| 007 | SET TO OFF | <p>Phase Reversal Protection N/A SPC 1-22 Model When using the nXt SPC in conjunction with a VFD set to OFF</p> |
| 008 | SET TO OFF | <p>Open Phase Protection N/A SPC 1-22 Model When using the nXt SPC in conjunction with a VFD set to OFF</p> |

11a.Program Parameters cont

| ITEM | DEFAULT | OPERATION |
|------|-------------------|--|
| 009 | 96 hrs | Anti-seize setting Range: 00 – 254hrs |
| 010 | Off | Boosting mode only – start delay time Range Off – 254 sec |
| 011 | Off | Boosting mode only – Stop delay time Range Off – 254 sec |
| 012 | Off | Boosting mode only – maximum run time Range Off – 254 min |
| 013 | Off | Fault Alarm audio setting When a fault has occurred activating the alarm, after the time specified in parameter #010 the continuous alarm will switch to a 'chirp mode' (beeping for 1 sec at 5-minute intervals) Range: 00 – 24 hrs |
| 014 | Off | Button Lock Function Options Off / On |
| 015 | 01 | RS485 - Controller ID Range 00 – 254 |
| 016 | 04 | RS485 – Baud Rate 01 = 1200, 02 = 2400, 03 = 4800, 04 = 9600 bps (default 9600bps) |
| 017 | 00 | RS485 Parity Check 00 = None, 01 = Odd Parity, 02 = Even Parity |
| 018 | 25.0A | Rated Output i.e. Pump Calibration Value Range: 0 – 25 Amps Whenever a replacement pump is installed, the previous calibration should be removed and a new calibration value entered |
| 019 | 75% | Trip response ratio – Dry run (underload) protection Range: Off – 95% |
| 020 | 130% | Trip response ratio – Over-load protection Range: Off – 170% |
| 021 | 180% | Trip response ratio – Pump stalled / locked rotor protection Range: Off – 195% |
| 022 | SET TO OFF | Trip response ratio – Phase imbalance N/A SPC 1-22 Model |
| 023 | 192V | Trip voltage – Under Voltage Protection Range 00 – 312 V |
| 024 | 276V | Trip voltage – Over Voltage Protection Range 00 – 312 V |
| 025 | 05 sec | Trip response time – Dry run Protection Range 1 – 553 sec |
| 026 | 45 min | Recovery time – Dry run Protection Range 1 – 60 min |
| 027 | 04 min | Recovery time – Overload protection Range 1 – 254 min |
| 028 | 04 min | Recovery time – Under/Over Voltage Range 00 – 60 min |

nXt-SPC Pro controllers offer a cost-effective and dependable solution for enhancing control and protection, eliminating the need for expensive customized switchboards.

On the following pages you'll find concise guides outlining typical applications. Once you grasp how the controller reacts to inputs across its modes, you'll discover its potential for applications beyond the standard suggestions.

For instance, you can integrate the controller in line with a VFD pump controller to introduce additional control inputs or capitalize on the nXt-SPC controller's delay capabilities.

For heightened flexibility in your setup, consider employing the nXt-SPC controller as a modular component within a more intricate control system.



Source control - Single float

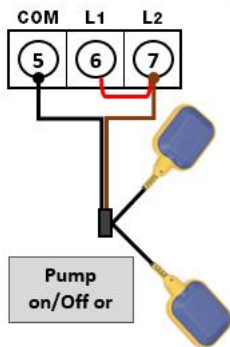

Floats

3 wire' floats allow for NO or NC wiring.

Connecting to the controller using the black and brown wires the circuit is closed when the float is up, open circuit when the float is down

When using a single float on the source input terminals, L1 and L2 must be bridged

Source control - dual float

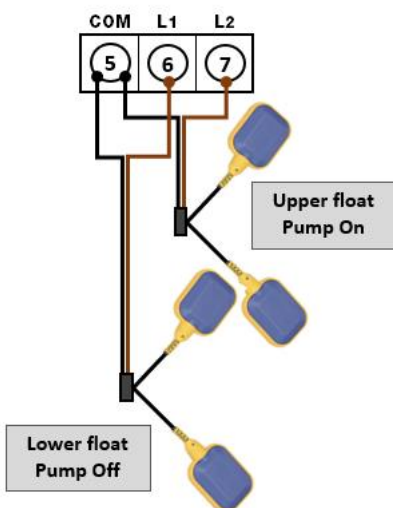

When the logic mode supports it, to achieve greater differential, dual floats may be attached to the source inputs COM + L1 and COM + L2.

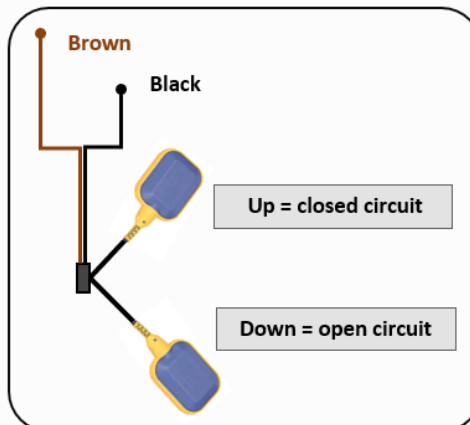

12. Quick guide: Drainage Mode, floats connected to control

Parameter 003 = **00** **Default mode as supplied**

A pump with its own float can be used in this configuration so long as the operational level of **Pump Stop Switch L1** is **HIGHER** than the float attached the pump.

DISPLAY

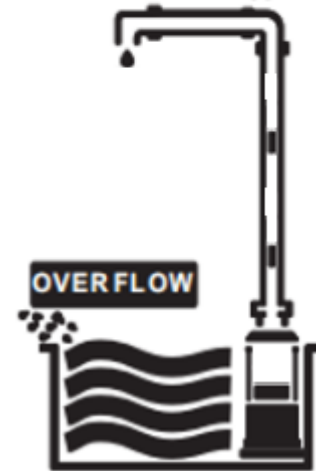

Source control - Single float

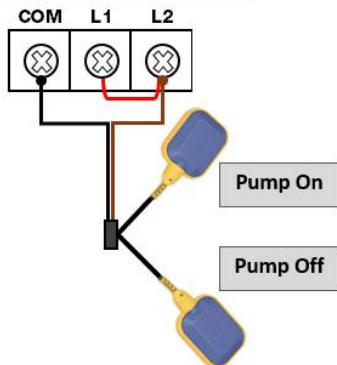

Single Float Control

COM and L1, L2 bridged

Closed to run. Open to stop

Pump switches on when the Pump Stop/Start switch is in the On (Up) position

Pump runs until the Pump Stop/Start switch is in the Off (Down) position

Source control - dual float

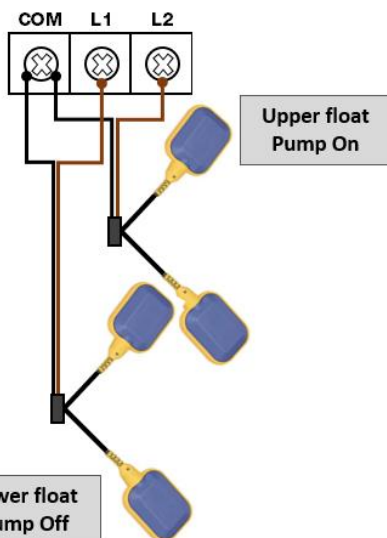

Dual Float Control

COM + L1

COM + L2

Pump switches on when the float switch connected to COM + L2 is in the On (Up) position

Pump runs until the float switch connected to COM + L1 is in the Off (Down) position

High level Alarm

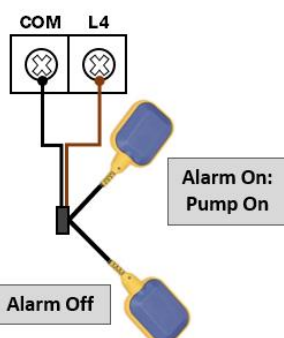

(Optional) High level Alarm

High-Level alarm triggers when the High-Level alarm float switch COM + L4 is in the closed circuit, On (Up) position.

The alarm will turn off when the Hi Level alarm switch connected to COM + L4 returns to the open circuit, Off (Down) position.

The pump continues to run until the Pump Stop/Start switch connected to COM + L1 is in the Off (Down) position

13. Quick guide: Drainage Mode, probes connected to control

Parameter 003 = **00**

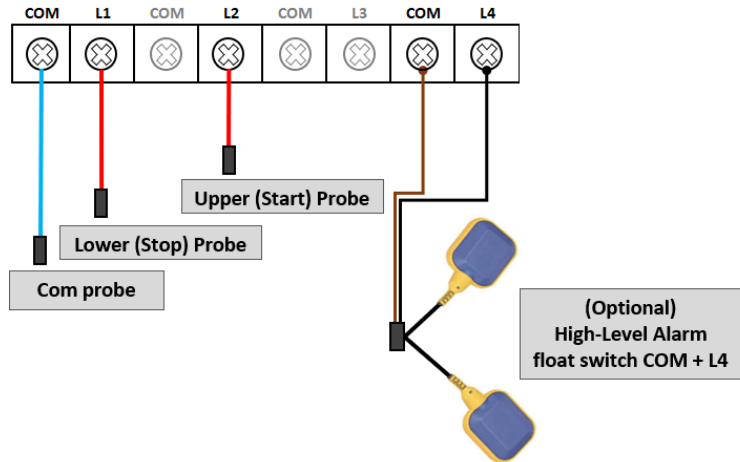

14. Quick guide: Drainage Mode, float connected to pump

Parameter 003 = **01**

Set to this operational mode, effectively there is power supplied to the pump continuously. The stop/start function is controlled by the float connected to the pump.

In this mode, underload (dry run) protection is not possible.

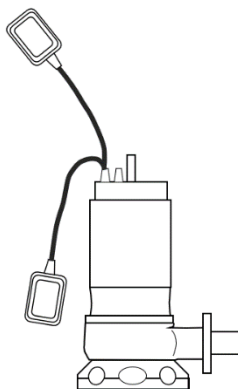

The pump On/Off operation is controlled by the float fitted to the pump.

The Controller provides additional protections **excluding** dry start/stop delay.

A float connected to the controller can provide high level alarm function

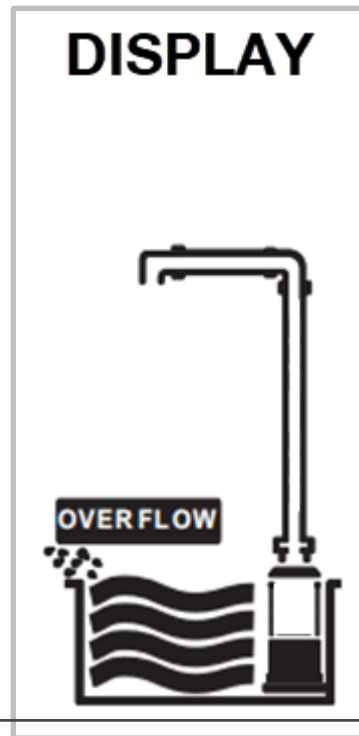

High level Alarm

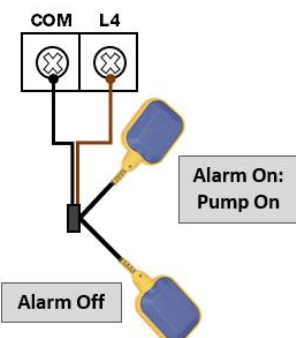

High level Alarm

High-Level alarm triggers when the High-Level alarm float switch COM + L4 is in the On (Up) position.

The alarm will turn off when the Hi Level alarm switch connected to COM + L4 returns to the Off (Down) position.

The pump continues to run until its control float is in the Off (Down) position

15. Quick guide: Pressure Boosting – switched input

Parameter 003 = **02**

Pump On/Off operation is controlled via a pressure switch on the delivery line.

Additional (optional) run/no run protection can be fitted at the source

Pumps used for pressure boosting controlled by a pressure switch MUST include a suitably sized pressure vessel to prevent excessive pump starts

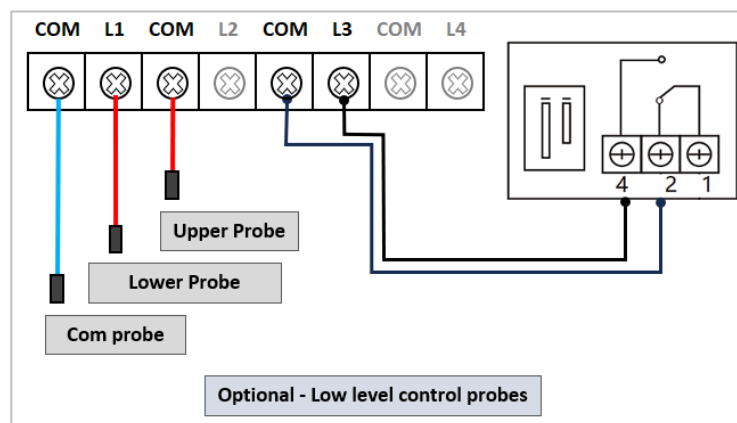
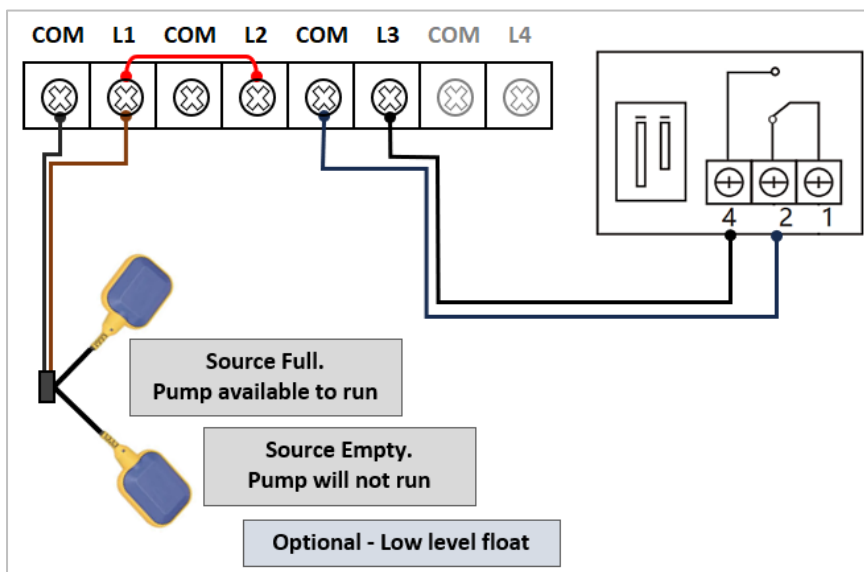
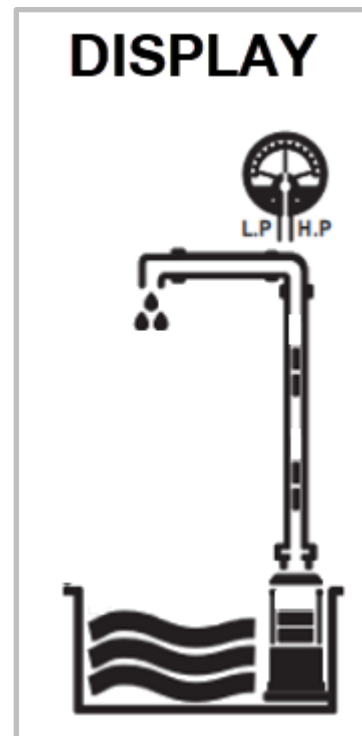

When the controller is set to Boosting Mode, Parameters 010 – 012 can be employed to provide additional control.

- Start delay time **Parameter 010** – Default Off
- Stop delay time: **Parameter 011** – Default Off
- Maximum Run time: **Parameter 012** – Default Off

Parameter 015 provides repeated start protection when in boosting mode

16. Quick guide: Transfer – source/destination control

Parameter 003 = **03**

Pump On/Off operation is requested by a float in the down (low level = ON) position at destination (or a pressure switch in the delivery line dropping to cut-in pressure)

A float switch or probes at the source controls whether the pump will run or not, depending on the liquid level.

A mixture of floats and probes can be used

In situations where the destination is a significant distance from the source it is possible to control by fitting a normally-open pressure switch to the delivery line OR to use a remote wireless sensor to trigger a switched input.

Connect across COM and L3, Bridge L3 to L4

DISPLAY

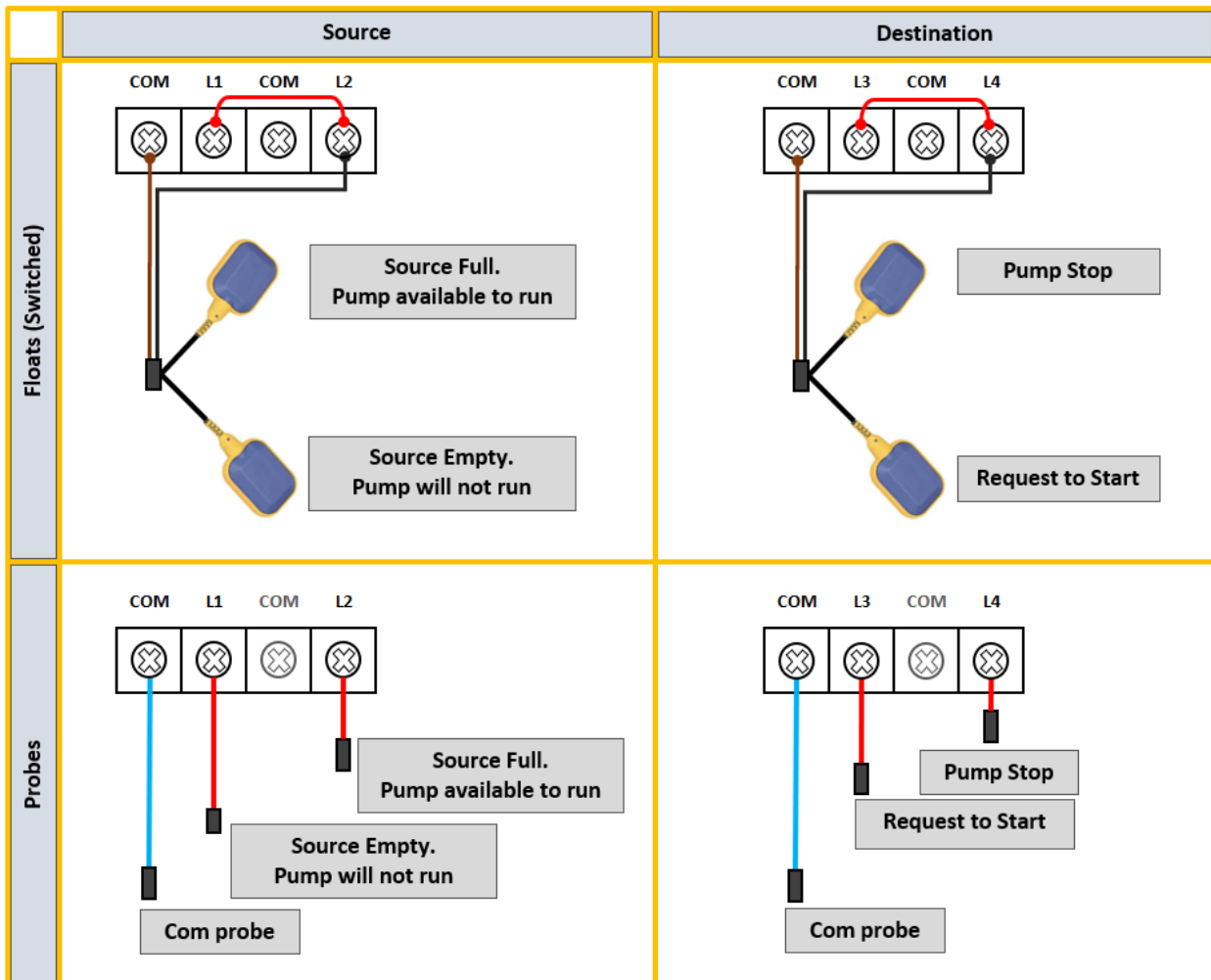

17. Quick guide: Drainage Mode, 4–20mA level transmitter

Parameter 003 = **04** **4-20mA input.**

A pump with its own float can be used in this configuration so long as the Parameter 030 is HIGHER than the level at which the pump float switches the pump off



Transmitter accuracy is a percentage of the sensor full range. Choose the 4-20mA level transmitter with a measuring range according to depth of source tank.

Set to Operational mode 04, four additional parameters are available. The installer must program the controller with the correct values. The values are in centimetres

- | | |
|---|----------------------|
| 1) Level transmitter full measuring range | Parameter 029 |
| 2) Pump cut-out/stop liquid level depth value | Parameter 030 |
| 3) Pump cut-in/start liquid level depth value | Parameter 031 |
| 4) Overflow alarm liquid level depth value | Parameter 032 |

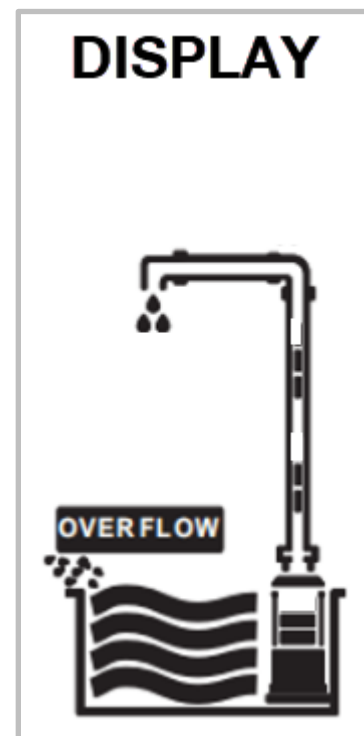

Example:

| | |
|----------------------------------|--------|
| Full measuring range: | 200 cm |
| Overflow alarm depth value: | 150 cm |
| Pump cut-in (start) depth value: | 100 cm |
| Pump cut-out (stop) depth value: | 20 cm |

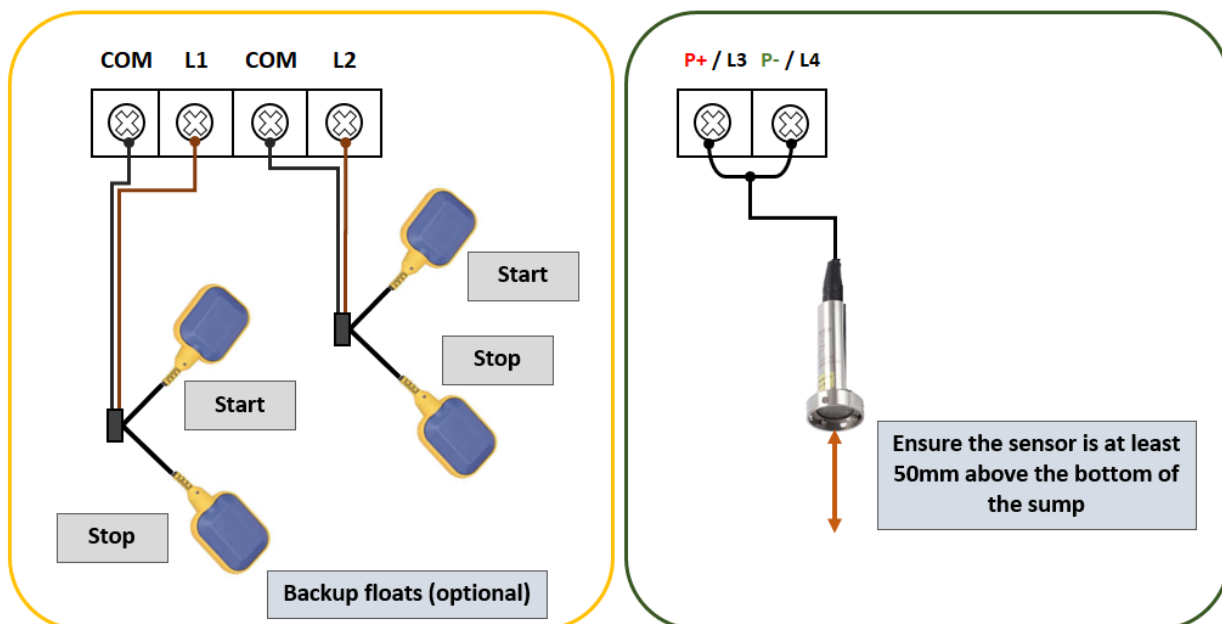

Set in drainage mode, if the controller detects the pump has not run for the time period value in Parameter 009 (default 96 hrs), the pump will start and run briefly to prevent the hydraulic components seizing.

18. Quick guide: Pressure Boosting 4-20mA

Parameter 003 = **05** 4-20mA input.

Pump On/Off operation is controlled via a 4-20mA pressure transducer

Additional (optional) run/no run protection can be fitted at the source

Set to Operational mode 05, four additional parameters are available. The installer must program the controller with the correct values. All values are in Bar

- | | |
|---|---------------|
| 1) Pressure sensor full measuring range | Parameter 029 |
| 2) Pump cut-out/stop pressure | Parameter 030 |
| 3) Pump cut-in/start pressure value | Parameter 031 |
| 4) Over pressure alarm value | Parameter 032 |

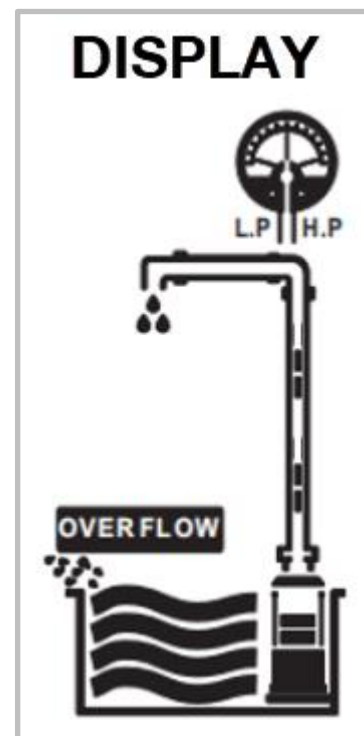

Example:

| | |
|-------------------------------|--------|
| Full measuring range: | 10 bar |
| Pump cut-in (start) pressure: | 2 bar |
| Pump cut-out (stop) pressure: | 4 bar |
| Over pressure alarm value: | 8 bar |

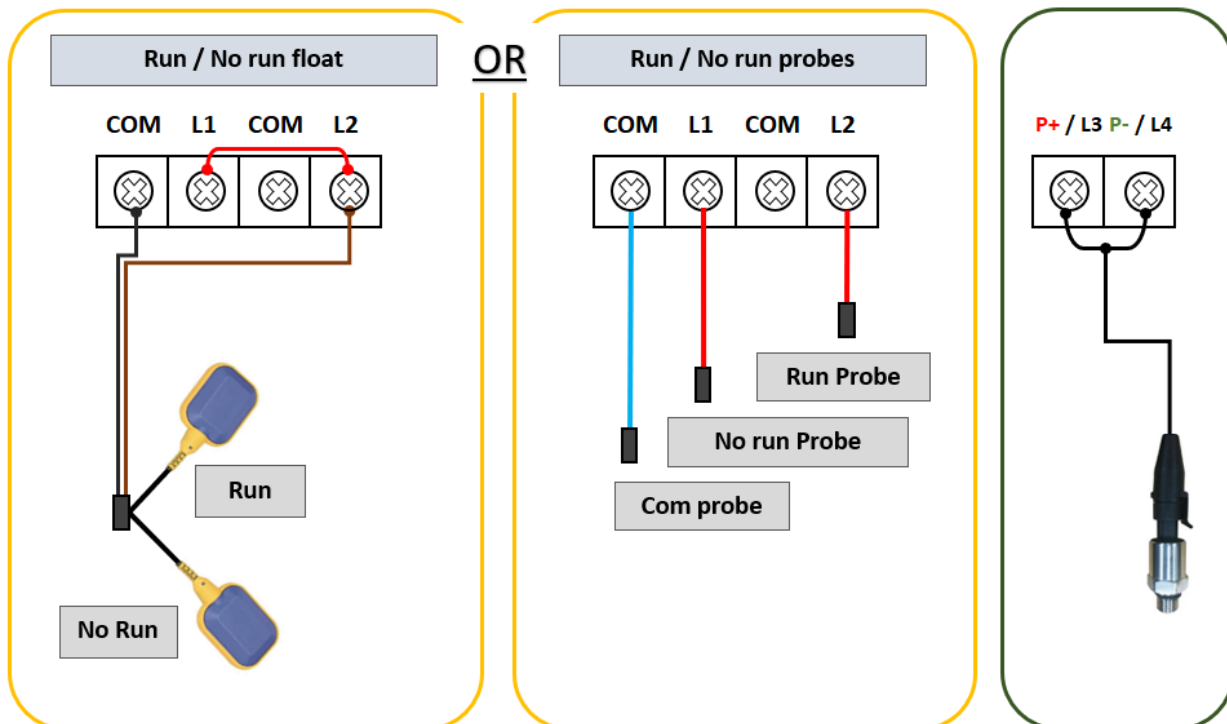

19. Quick guide: Transfer – source/destination control 4-20mA

Parameter 003 = **06** 4-20mA input.



Transmitter accuracy is a percentage of the sensor full range. Choose the 4-20mA level transmitter with a measuring range according to depth of source tank.

The destination control (level sensor) provides a request to start based on liquid level.

A float switch or probes at the source controls whether the pump will run or not, depending on the liquid level.

Set to Operational mode 06, four additional parameters are available. The installer must program the controller with the correct values. The values are in centimetres

- 1) Level transmitter full measuring range
- 2) Overflow alarm liquid level depth
- 3) Pump cut-in/start liquid level depth
- 4) Pump cut-out/stop liquid level depth

- Parameter 029
- Parameter 029
- Parameter 028
- Parameter 027

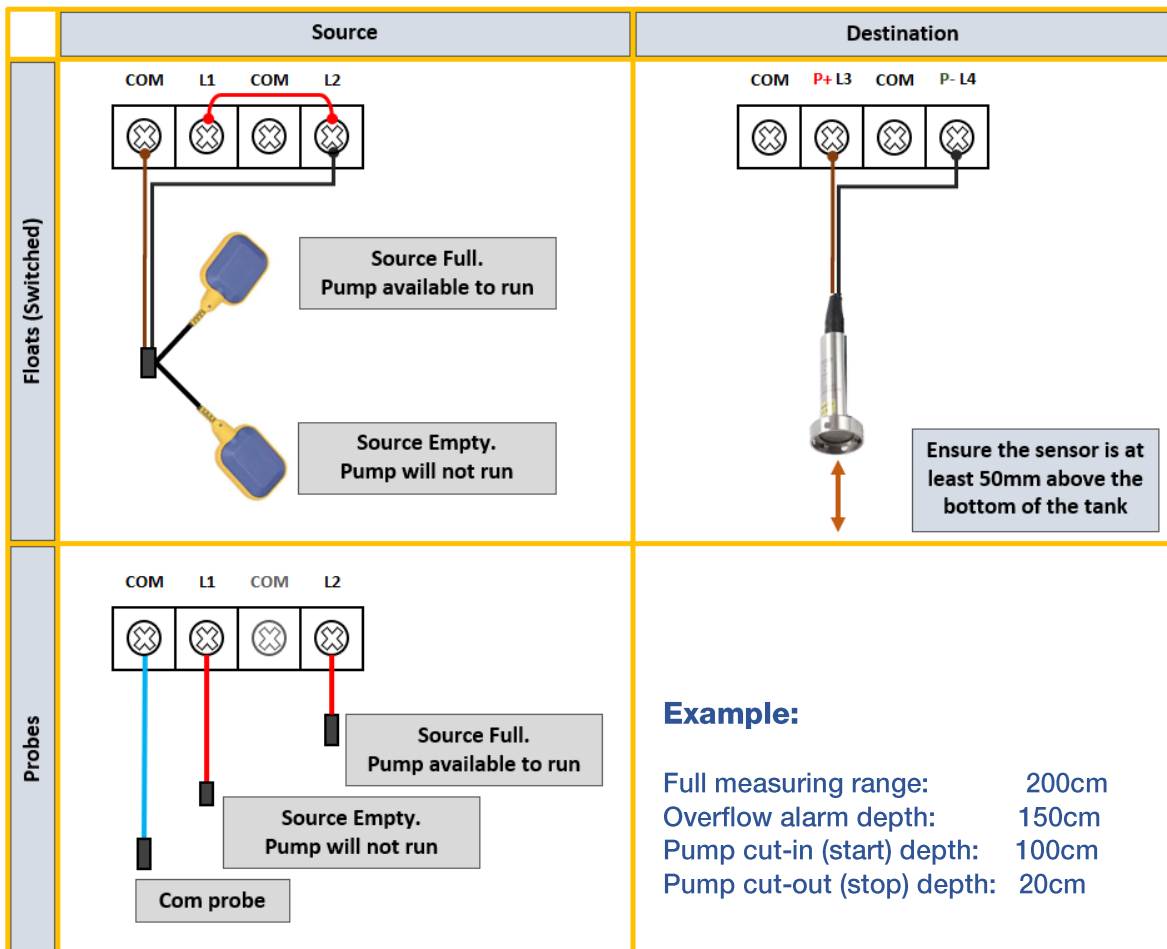
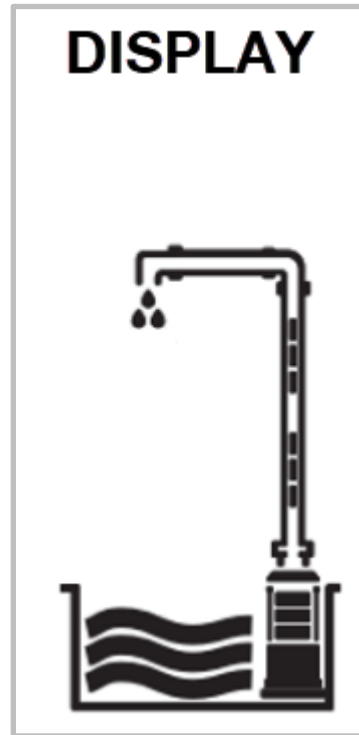

20. Backup power supply

In some regions battery backup for the high-level alarm is mandated.

Connecting a 24v battery pack will maintain the alarm and control circuit in case of a mains power failure.

When mains power falls, the unit will display in input voltage (24V) and the Under-Voltage warning message will display on the screen. The pump will not attempt to run, the backup power supply is only to ensure the Hi-Level alarm is able to function for as long as the backup battery maintains its output

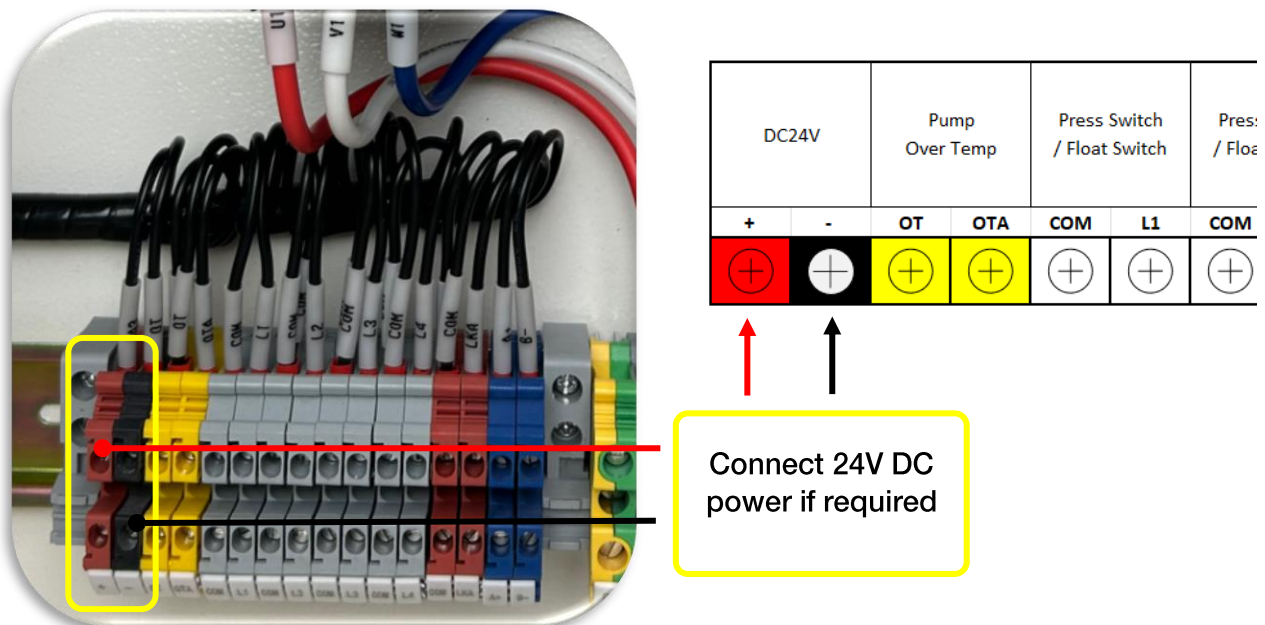

External Alarm







The PLC has an inbuilt audible alarm.

The External Audible / Visual alarm light supplied with the nXt DPC Pro panel receives pulses of 24V DC power from the PLC (JB2, JB3).

An additional 24V DC external, remote alarm can be fitted and wired in parallel.



21. Accessories

| Image | Description | Part # |
|---|--|--|
|  | Capacitance Probe | 805321 |
|  | 4-20mA pressure transducer 1MPA | 802680 |
|  | 4-20mA level transducer 2m | 804528 |
|  | SK12(5M) H05 10 amp SK12(10M) H05 10 amp SK12(20M) H05 10 amp SK12(30M) H05 10 amp FSK1 (5m) H07 10 amp FSK1 (10m) H07 16 amp FSK1-20 (20m) H07 16 amp | 700965 700962 700963 700964 809941 700610 700611 |
|  | FSK1.1(10m) H07 10 amp | 801125 |
|  | Float switch counter-weight | 700967 |
|  | Pressure switch (NC) 6 bar Pressure switch (NC) 12 bar Reverse acting pressure switch (NO) 5.5 bar Reverse acting pressure switch (NO) 10 bar | 701440 701380 809863 809864 |

22. Fault Messages

| Fault Message | Possible Cause | Potential Solutions |
|--------------------------------------|---|---|
| UNDER V | The actual running voltage is lower than the calibrated voltage parameter 023 . The pump is in an under-voltage protection state | The controller will attempt to restart the pump every 5 minutes until line voltage is restored to normal If this fault occurs repeatedly, report low line voltage to the power supply company |
| OVER V | The actual running voltage is higher than the calibrated voltage parameter 024 . The pump is in over-voltage protection state | The controller will attempt to restart the pump every 5 minutes until line voltage is restored to normal If this fault occurs repeatedly, report high line voltage to the power supply company |
| PUMP STALLED | The pump motor running amperage has exceeded the normal (calibrated) running amperage by more than parameter 021 (default value 170%) This could be due to physical jamming or a mechanical issue. If the pump stalled error occurs repeatedly at commissioning check the controller rating is matched to the pump | Pump Stalled is a 'critical error' and will not automatically reset. Isolate the power supply and inspect the pump for anything which has caused the sudden increase in load |
| OVER LOAD | Pump motor running amperage exceeds the normal (calibrated) running amperage by more than parameter 020 (default value 130%) | Isolate the power supply and inspect the pump for anything which is causing the pump to draw more amperage than the initial calibration value |
| UNDER LOAD | Pump motor running amperage is less than the normal (calibrated) running amperage by more than parameter 019 (default value 75%) | Under-load is sometimes referred to as Dry-run protection as a pump motor will draw less current when there is no load. |
| OPEN PHASE | The power supply has lost a phase. | Check fuses and wiring. |
| PUMP NO CALIBRATION | Calibration not complete | Check the calibration Parameter 018 |
| OVER TEMP Parameter 006 ON | The temperature in the pump motor is high causing the thermal switch (if fitted) to operate | Investigate the cause of the overheating. |
| PUMP LEAKAGE | The pump moisture sensor has detected moisture inside the pump body | Service or replace pump |

23. Warranties – Terms and Conditions

This warranty is given in addition to the consumer guarantees found within the Australian Competition and Consumer Act 2010 (Cth) for goods purchased in Australia and the Consumer Guarantees Act 1993 NZ for goods purchased in New Zealand:



1) White International Pty Ltd / White International NZ Ltd (White International) warrant that all products distributed are free from defects in workmanship and materials, for their provided warranty period as indicated on the top or opposite side of this document. Subject to the conditions of the warranty, White International will repair any defective products free of charge at the premises of our authorised service agents throughout Australia and New Zealand if a defect in the product appears during the warranty period. If you believe that you have purchased a defective product and wish to make a claim under this warranty, contact us on our Sales Hotline on 1300 783 601, or send your claim to our postal address or fax line below and we will advise you as to how next to proceed. You will be required to supply a copy of your proof of purchase to make a claim under this warranty.

2) This warranty excludes transportation costs to and from White International or its appointed service agents and excludes defects due to non-compliance with installation instructions, neglect or misuse, inadequate protection against the elements, low voltage or use or operation for purposes other than those for which they were designed. For further information regarding the suitability of your intended application contact us on our Sales Hotline on 1300 783 601. If you make an invalid claim under this warranty, the original product will be sent back to you unrepai red.

3) This warranty refers only to products sold after the 1st January 2012, and is not transferable to another product type and only applies to the original owner, purchaser or end user, and is in addition to the consumer guarantees found within the Competition and Consumer Act 2010 (Cth) for goods purchased in Australia and the Consumer Guarantees Act 1993 (NZ) for goods purchased in New Zealand.

4) Our goods come with guarantees that cannot be excluded under the Australian Consumer Law. You are entitled to a replacement or refund for a major failure and for compensation for any other reasonably foreseeable loss or damage. You are also entitled to have the goods repaired or replaced if the goods fail to be of acceptable quality and the failure does not amount to a major failure. 2 YEAR WARRANTY

5) To the fullest extent permitted by law, White International excludes its liability for all other conditions or warranties which would or might otherwise be implied at law. To the fullest extent permitted by law, White International's liability under this warranty and any other conditions, guarantees or warranties at law that cannot be excluded, including those in the Competition and Consumer Act 2010 (Cth), is expressly limited to: (a) in the case of products, the replacement of the product or the supply of equivalent product, the payment of the cost of replacing the product or of acquiring an equivalent product or the repair of the product or payment of the cost of having the product repaired, is at the discretion of White International or a 3rd party tribunal elected under the Competition and Consumer Act 2010 (Cth) for goods purchased in Australia and the Consumer Guarantees Act 1993 (NZ) for goods purchased in New Zealand; and

6) To the fullest extent permitted by law, this warranty supersedes all other warranties attached to the product or its packaging.

7) In the case of services, supplying the services again or the payment of the cost of having the services supplied again, is at the discretion of White International or a 3rd party tribunal elected under the Competition and Consumer Act 2010 (Cth) for goods purchased in Australia and the Consumer Guarantees Act 1993 (NZ) for goods purchased in New Zealand. 8) Our warranty commences from the date of purchase of the above-mentioned pumps. Proof of purchase is required before consideration under warranty is given.

Record your date of purchase in the space below and retain this copy for your records.

Date of Purchase**Model Purchased**



www.whiteint.com.au

1300 783 601

www.whiteint.co.nz

0800 509 506

Please always refer to our website for further technical information & new product innovations

Disclaimer: Every effort has been made to publish the correct information in this manual. No responsibility will be taken for errors, omissions or changes in product specifications.

© 2024 Copyright White International Pty Ltd

TM ® - WARNING: Please be aware that various brands & products depicted within this document are subject to trademark, patent or design registrations. Infringement of any intellectual property contained within this document without express written authority by the appropriate intellectual property holder may result in further legal action to be taken. For any queries regarding use of the contained information please feel free to contact White International Pty Ltd.